

## 400mA PCI LDO

### Features

- Glitch Free Transition Between Input Sources
- Automatic Input Source Selection
- External PMOS Bypass Switch Control
- Built-in 5V Detector
- 1% Regulated Output Voltage Accuracy
- 400mA Load Current Capability
- Kelvin Sense Input
- Low Ground Current, Independent of Load

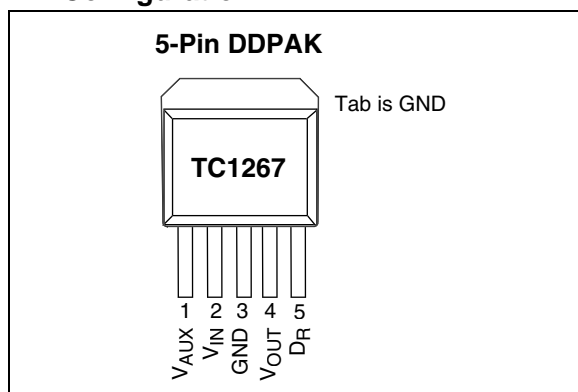
### Applications

- PCMCIA
- PCI
- Network Interface Cards (NICs)
- Cardbus™ Technology
- Desktop Computers

### Device Selection Table

Part Number	Package	Junction Temp. Range
TC1267VET	5-Pin DDPACK	-5°C to +95°C

### Pin Configuration

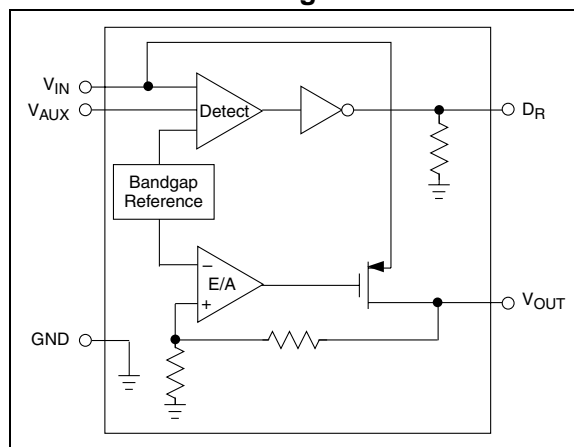


### General Description

The TC1267 is an application-specific, low dropout regulator (LDO), specifically intended for use in PCI peripheral card applications complying with PCI Power Management (PCI 2.0). It provides an uninterrupted, 3.3V output voltage when the main (5V) or auxiliary (3.3V) input voltage supplies are present.

The TC1267 consists of an LDO, a voltage threshold detector, external switchover logic and gate drive circuitry. It functions as a conventional LDO as long as the voltage on the main supply input ( $V_{IN}$ ) is above the lower threshold (3.90V typical). Should the voltage on  $V_{IN}$  fall below the lower threshold, the LDO is disabled and an external P-channel MOSFET is automatically turned on, connecting the auxiliary supply input to  $V_{OUT}$ , and ensuring an uninterrupted 3.3V output. The main supply is automatically selected, if both the main and auxiliary input supplies are present, and transition from one input supply to the other is ensured glitch-free. High integration, automatic secondary supply switchover, Kelvin sensing, and small size make the TC1267 the optimum LDO for PCI 2.0 applications.

### Functional Block Diagram



# TC1267

## 1.0 ELECTRICAL CHARACTERISTICS

### Absolute Maximum Ratings\*

Input Supply Voltage ( $V_{IN}$ ).....-0.5V to +7V (Max)  
 Auxiliary Supply Voltage ( $V_{AUX}$ ) .....-0.5V to +7V (Max)  
 LDO Output Current ( $I_{OUT}$ ).....400mA  
 Thermal Impedance,  
 Junction-to-Ambient ( $\theta_{JA}$ )..... 27°C/W for DDPAK  
 ESD Rating ..... 2 KV  
 Operating Temperature Range ( $T_A$ ).....-5°C to +70°C  
 Storage Temperature Range ( $T_{STG}$ )...-65°C to +150°C

\*Stresses above those listed under "Absolute Maximum Ratings" may cause permanent damage to the device. These are stress ratings only and functional operation of the device at these or any other conditions above those indicated in the operation sections of the specifications is not implied. Exposure to Absolute Maximum Rating conditions for extended periods may affect device reliability.

### TC1267 ELECTRICAL SPECIFICATIONS

<b>Electrical Characteristics:</b> $T_A = +25^\circ\text{C}$ , $V_{IN} = 5\text{V}$ , $V_{AUX} = 3.3\text{V}$ , $I_{OUT} = 0.1\text{mA}$ , $C_{OUT} = 4.7\mu\text{F}$ , unless otherwise noted. <b>Boldface</b> type specifications apply over full operating range.						
Symbol	Parameter	Min	Typ	Max	Units	Test Conditions
$V_{IN}$	Supply Voltage	<b>4.4</b>	<b>5.0</b>	<b>5.5</b>	V	$V_{AUX} = 0\text{V}$
$I_{GND}$	Ground Current	—	230	<b>450</b> <b>500</b>	$\mu\text{A}$	$V_{AUX} = 0\text{V}$ ( <b>Note 6</b> ) $V_{AUX} = 3.3\text{V}$ ( <b>Note 6</b> )
$I_{VIN}$	Reverse Leakage from $V_{AUX}$	—	-0.1	<b>-1.0</b>	$\mu\text{A}$	$V_{AUX} = 3.5\text{V}$ , $V_{IN} = 0\text{V}$ , $I_{OUT} = 0\text{mA}$
$V_{AUX}$	Supply Voltage	<b>3.0</b>	<b>3.3</b>	<b>3.6</b>	V	
$I_{Q(AUX)}$	Quiescent Current	—	50	70	$\mu\text{A}$	$V_{IN} = 0\text{V}$ , $I_{OUT} = 0\text{mA}$
		—	—	<b>100</b>		
		—	60	80	$\mu\text{A}$	$V_{IN} = 5\text{V}$ , $I_{OUT} = 0\text{mA}$
		—	—	<b>120</b>		
$I_{VAUX}$	Reverse Leakage from $V_{IN}$	—	-0.1	<b>-1.0</b>	$\mu\text{A}$	$V_{IN} = 5.5\text{V}$ , $V_{AUX} = 0\text{V}$ , $I_{OUT} = 0\text{mA}$
$V_{TH(LO)}$	5V Detector Low Threshold Voltage	—	3.90	—	V	$V_{IN}$ Falling ( <b>Notes 2, 3</b> )
		<b>3.75</b>	—	<b>4.05</b>		
$V_{HYST}$	5V Detector Hysteresis Voltage	—	260	—	mV	<b>(Notes 2, 3)</b>
		<b>200</b>	—	<b>300</b>		
$V_{TH(HI)}$	5V Detector High Threshold Voltage	—	4.15	—	V	$V_{IN}$ Rising ( <b>Notes 2, 3</b> )
		<b>4.0</b>	—	<b>4.30</b>		
$V_{OUT}$	LDO Output Voltage	—	3.300	—	V	$I_{OUT} = 20\text{mA}$
		<b>3.201</b>	—	<b>3.366</b>	V	$4.4\text{V} \leq V_{IN} \leq 5.5\text{V}$ , $0\text{mA} \leq I_{OUT} \leq 400\text{mA}$
		<b>3.000</b>	—	—	V	$0\text{mA} \leq I_{OUT} \leq 400\text{mA}$ ( <b>Note 4</b> )
$I_{OUT}$	Output Current	400	—	—	mA	
		—	—	—		
$REG_{(LINE)}$	Line Regulation	—	0.05	—	%	$V_{IN} = 4.3\text{V}$ to $5.5\text{V}$
		<b>-0.5</b>	—	<b>+0.5</b>		
$REG_{(LOAD)}$	Load Regulation	—	-0.1	—	%	$I_{OUT} = 0.1\text{mA}$ to $400\text{mA}$
		<b>-1.5</b>	—	<b>+0.5</b>		
$V_{DR}$	Drive Voltage	$V_{IN} - 0.2$	$V_{IN} - 0.1$	—	V	$4.3\text{V} \leq V_{IN} \leq 5.5\text{V}$ , $I_{DR} = 200\mu\text{A}$
		<b><math>V_{IN} - 0.3</math></b>	—	—		
		—	35	150	mV	$V_{IN} < V_{TH(LO)}$ , $I_{DR} = 200\mu\text{A}$
		—	—	<b>200</b>		

- Note**
- 1: Ensured by design.
  - 2: See 5V Detect Thresholds, Figure 4-1.
  - 3: Recommended source impedance for 5V supply:  $\leq 0.25\Omega$ . This will ensure that  $I_{OUT} \times R_{SOURCE} < V_{HYST}$ , thus avoiding  $D_R$  toggling during 5V detect threshold transitions.
  - 4: In Application Circuit, Figure 3-1.
  - 5: See Timing Diagram, Figure 4-2.
  - 6: Ground Current is independent of  $I_{LOAD}$ .

## TC1267 ELECTRICAL SPECIFICATIONS (CONTINUED)

**Electrical Characteristics:**  $T_A = +25^\circ\text{C}$ ,  $V_{IN} = 5\text{V}$ ,  $V_{AUX} = 3.3\text{V}$ ,  $I_{OUT} = 0.1\text{mA}$ ,  $C_{OUT} = 4.7\mu\text{F}$ , unless otherwise noted. **Boldface** type specifications apply over full operating range.

Symbol	Parameter	Min	Typ	Max	Units	Test Conditions
$I_{DR(PK)}$	Peak Drive Current	7 <b>6</b>	— —	— —	mA	Sinking: $V_{IN} = 3.75\text{V}$ , $V_{DR} = 1\text{V}$ ; Sourcing: $V_{IN} = 4.3\text{V}$ , $V_{IN} - V_{OR} = 2\text{V}$
$t_{DH}$	Drive High Delay (Notes 1, 5)	— —	4 —	— <b>8</b>	$\mu\text{sec}$	$C_{DR} = 1.2\text{nF}$ , $V_{IN}$ ramping up, measured from $V_{IN} = V_{TH(HI)}$ to $V_{DR} = 2\text{V}$
$t_{DL}$	Drive Low Delay (Notes 1, 5)	— —	0.6 —	1.5 <b>3.0</b>	$\mu\text{sec}$	$C_{DR} = 1.2\text{nF}$ , $V_{IN}$ ramping down, measured from $V_{IN} = V_{TH(LO)}$ to $V_{DR} = 2\text{V}$

- Note**
- 1: Ensured by design.
  - 2: See 5V Detect Thresholds, Figure 4-1.
  - 3: Recommended source impedance for 5V supply:  $\leq 0.25\Omega$ . This will ensure that  $I_{OUT} \times R_{SOURCE} < V_{HYST}$ , thus avoiding  $D_R$  toggling during 5V detect threshold transitions.
  - 4: In Application Circuit, Figure 3-1.
  - 5: See Timing Diagram, Figure 4-2.
  - 6: Ground Current is independent of  $I_{LOAD}$ .

# TC1267

## 2.0 PIN DESCRIPTIONS

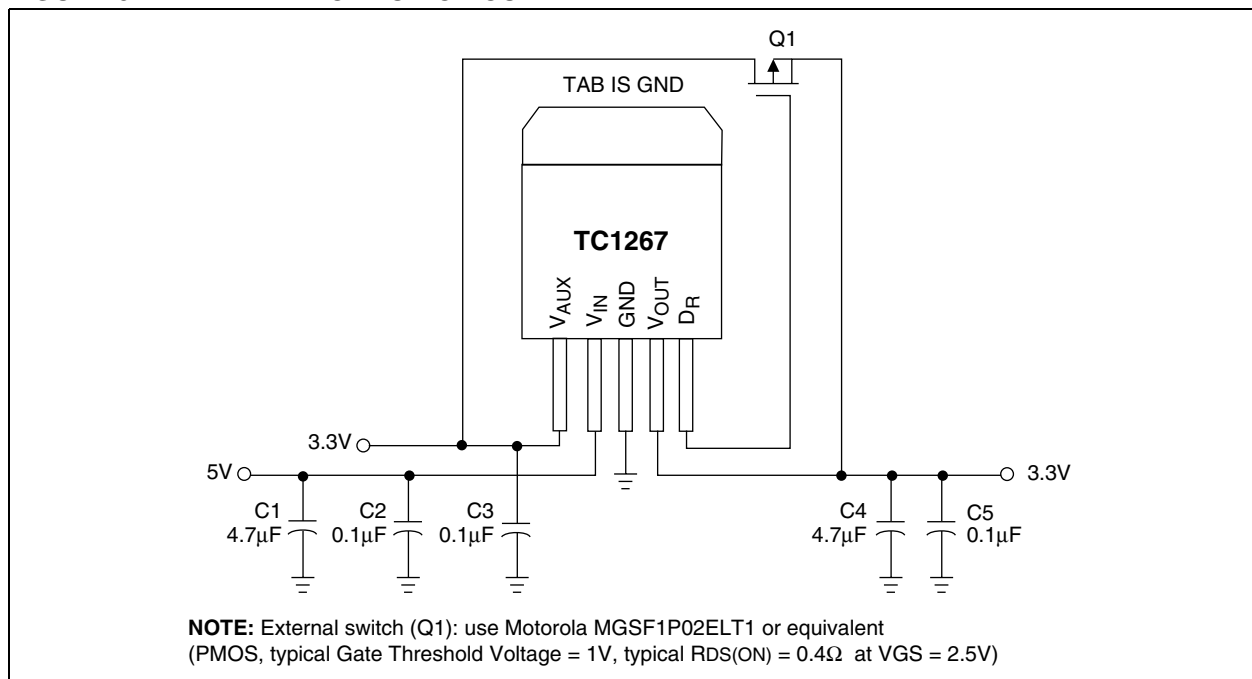
The descriptions of the pins are listed in Table 2-1.

TABLE 2-1: PIN FUNCTION TABLE

Pin No.	Symbol	Description
1	V <sub>AUX</sub>	Auxiliary input supply, nominally 3.3V.
2	V <sub>IN</sub>	Main input supply for the TC1267, nominally 5V.
3	GND	Logic and power ground.
4	V <sub>OUT</sub>	LDO 3.3V output.
5	D <sub>R</sub>	Driver output for external P-channel MOSFET pass element.

## 3.0 DETAILED DESCRIPTION

FIGURE 3-1: APPLICATION CIRCUIT



## 4.0 THERMAL CONSIDERATIONS

### 4.1 Thermal Shutdown

Integrated thermal protection circuitry shuts the regulator off when die temperature exceeds 160°C. The regulator remains off until the die temperature drops to approximately 150°C.

### 4.2 Power Dissipation

The amount of power the regulator dissipates is primarily a function of input and output voltage, and output current. The following equation is used to calculate worst case actual power dissipation:

#### EQUATION 4-1:

$$P_D \approx (V_{INMAX} - V_{OUTMIN})I_{LOADMAX}$$

Where:

- $P_D$  = Worst case actual power dissipation
- $V_{INMAX}$  = Maximum voltage on  $V_{IN}$
- $V_{OUTMIN}$  = Minimum regulator output voltage
- $I_{LOADMAX}$  = Maximum output (load) current

The maximum allowable power dissipation (Equation 4-2) is a function of the maximum ambient temperature ( $T_{AMAX}$ ), the maximum allowable die temperature ( $T_{JMAX}$ ) and the thermal resistance from junction-to-air ( $\theta_{JA}$ ).

#### EQUATION 4-2:

$$P_{DMAX} = \frac{(T_{JMAX} - T_{AMAX})}{\theta_{JA}}$$

Where all terms are previously defined.

Table 4-1 shows various values of  $\theta_{JA}$  for the TC1267 packages.

**TABLE 4-1: THERMAL RESISTANCE GUIDELINES FOR TC1267 IN 5-PIN DDPAK**

Copper Area (Topside)*	Copper Area (Backside)	Board Area	Thermal Resistance ( $\theta_{JA}$ )
2500 sq mm	2500 sq mm	2500 sq mm	25°C/W
1000 sq mm	2500 sq mm	2500 sq mm	27°C/W
125 sq mm	2500 sq mm	2500 sq mm	35°C/W

\*Tab of device attached to topside copper.

Equation 4-1 can be used in conjunction with Equation 4-2 to ensure regulator thermal operation is within limits. For example:

Given:

$$\begin{aligned} V_{INMAX} &= 5V \pm 5\% \\ V_{OUTMIN} &= 3.217V \\ I_{LOADMAX} &= 400mA \\ T_{JMAX} &= 95^\circ C \\ T_{AMAX} &= 70^\circ C \\ \theta_{JA} &= 27^\circ C/W \text{ (DDPAK mounted on} \\ &\quad \text{1000 sq mm topside copper area)} \end{aligned}$$

Find: 1. Actual power dissipation  
2. Maximum allowable dissipation

Actual power dissipation:

$$\begin{aligned} P_D &\approx (V_{INMAX} - V_{OUTMIN})I_{LOADMAX} \\ &= (5.25V - 3.217V) 400mA \\ &= 813mW \end{aligned}$$

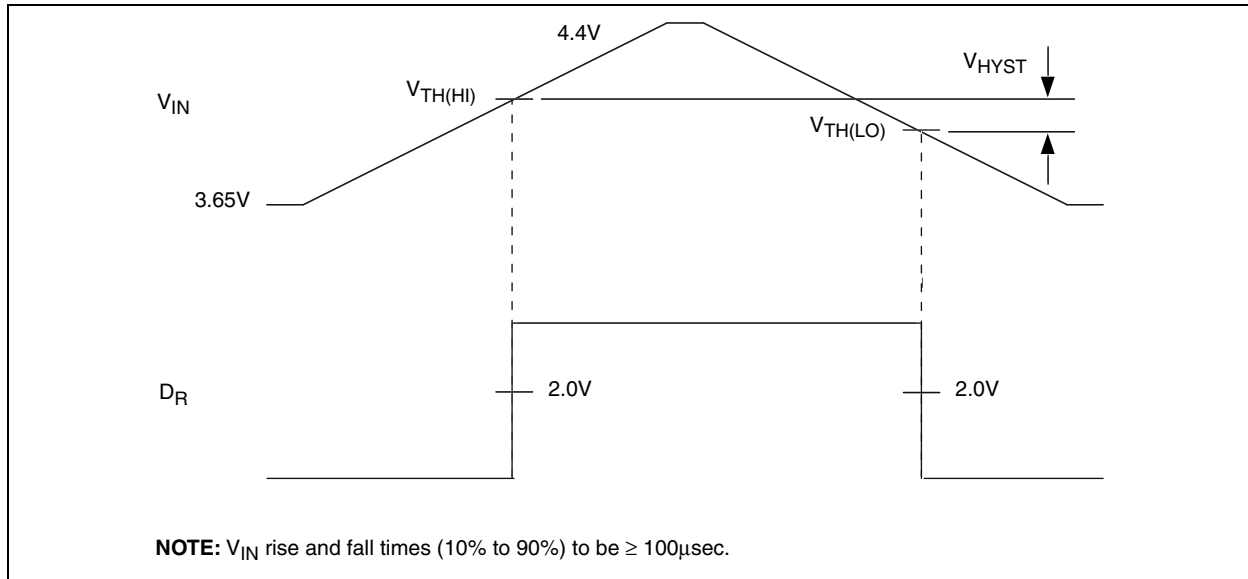
Maximum allowable power dissipation:

$$\begin{aligned} P_{DMAX} &= \frac{(T_{JMAX} - T_{AMAX})}{\theta_{JA}} \\ &= \frac{(95 - 70)}{27} \\ &= 423mW \end{aligned}$$

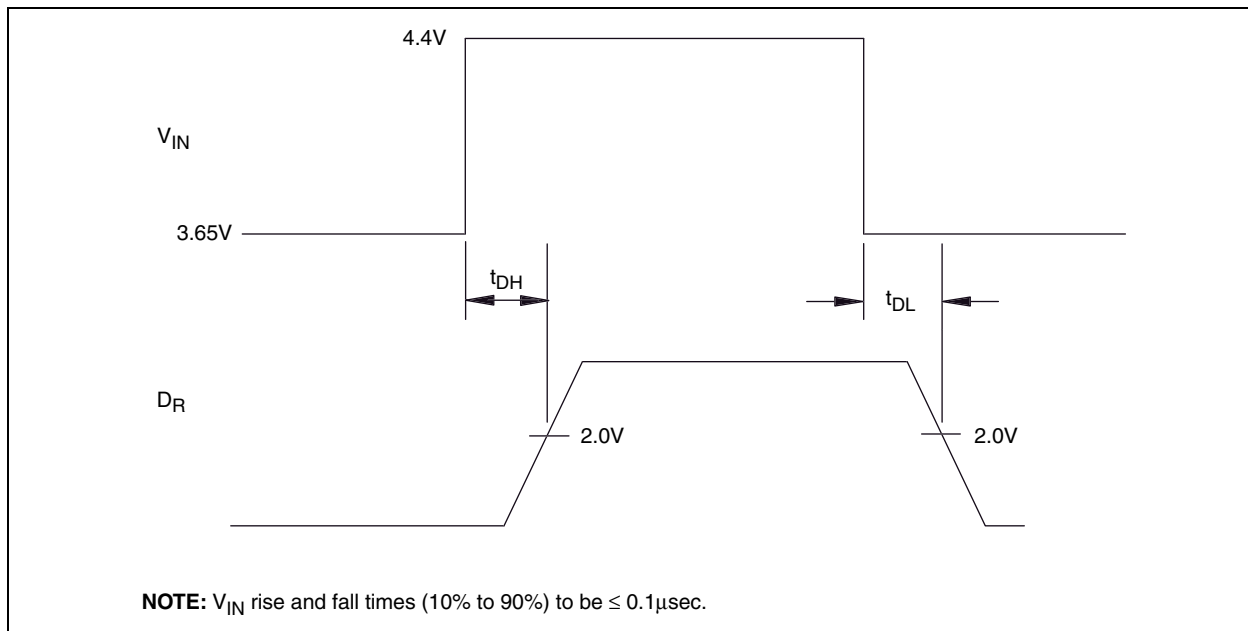
In this example, the TC1267 dissipates a maximum of 813mW; below the allowable limit of 926mW.

# TC1267

**FIGURE 4-1: 5V DETECT THRESHOLD**

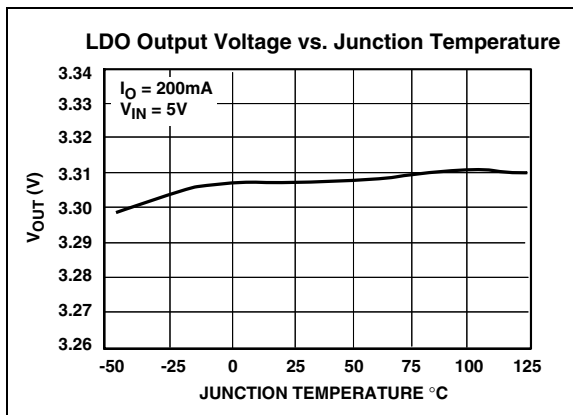
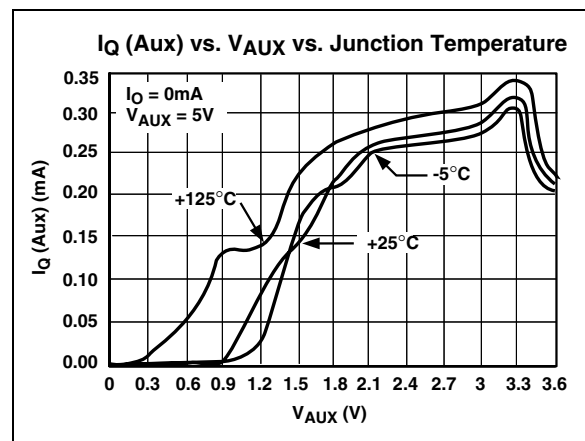
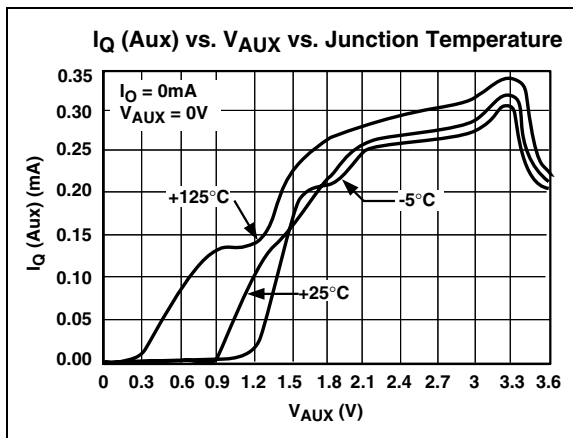
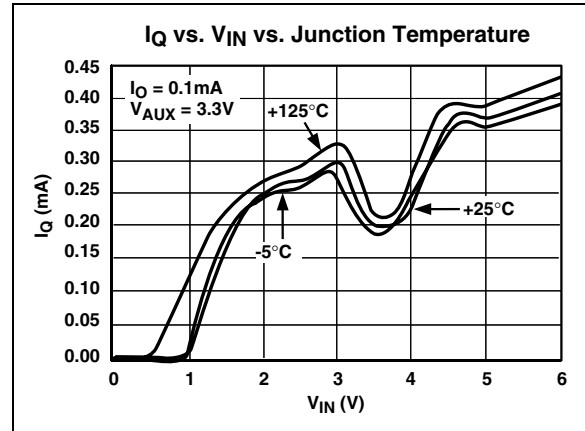
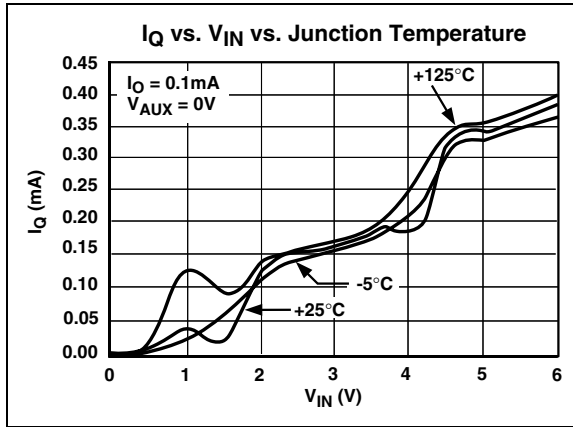


**FIGURE 4-2: TIMING DIAGRAM**

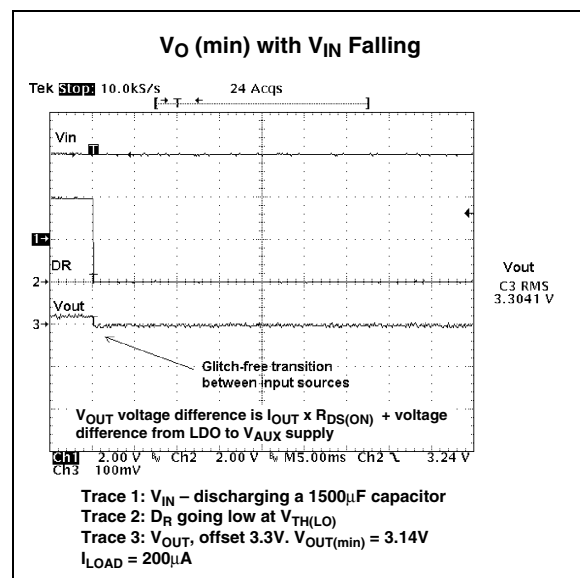
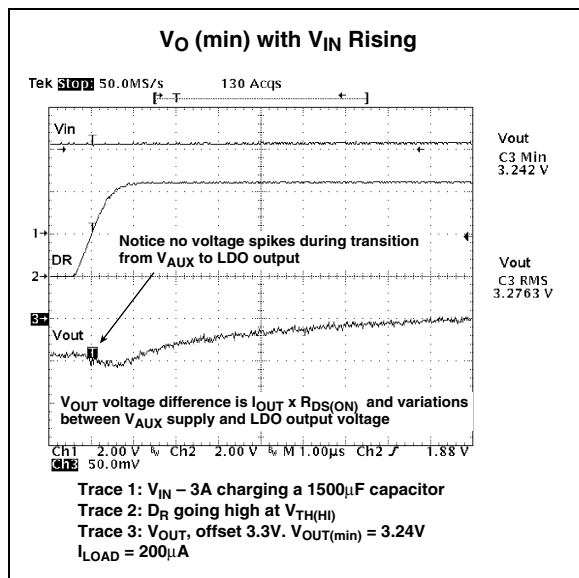
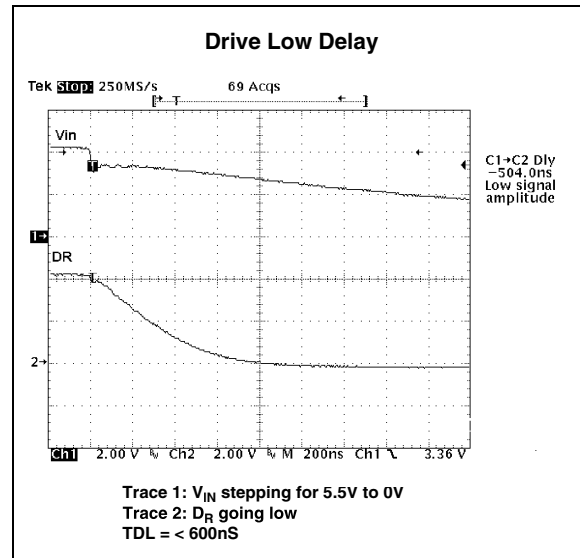
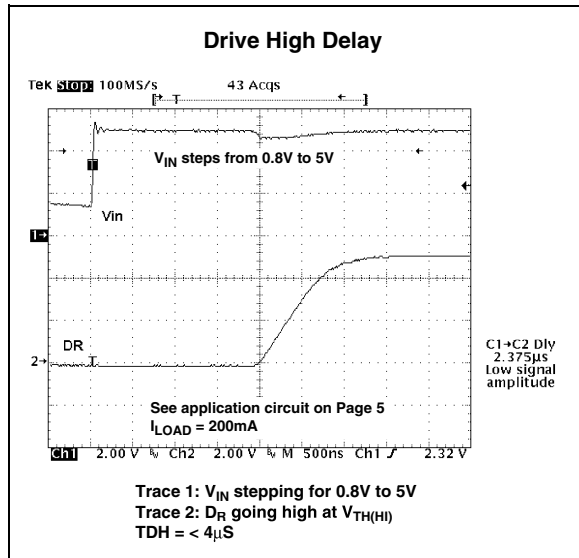


## 5.0 TYPICAL CHARACTERISTICS

**Note:** The graphs and tables provided following this note are a statistical summary based on a limited number of samples and are provided for informational purposes only. The performance characteristics listed herein are not tested or guaranteed. In some graphs or tables, the data presented may be outside the specified operating range (e.g., outside specified power supply range) and therefore outside the warranted range.



## 5.0 TYPICAL CHARACTERISTICS (CONTINUED)



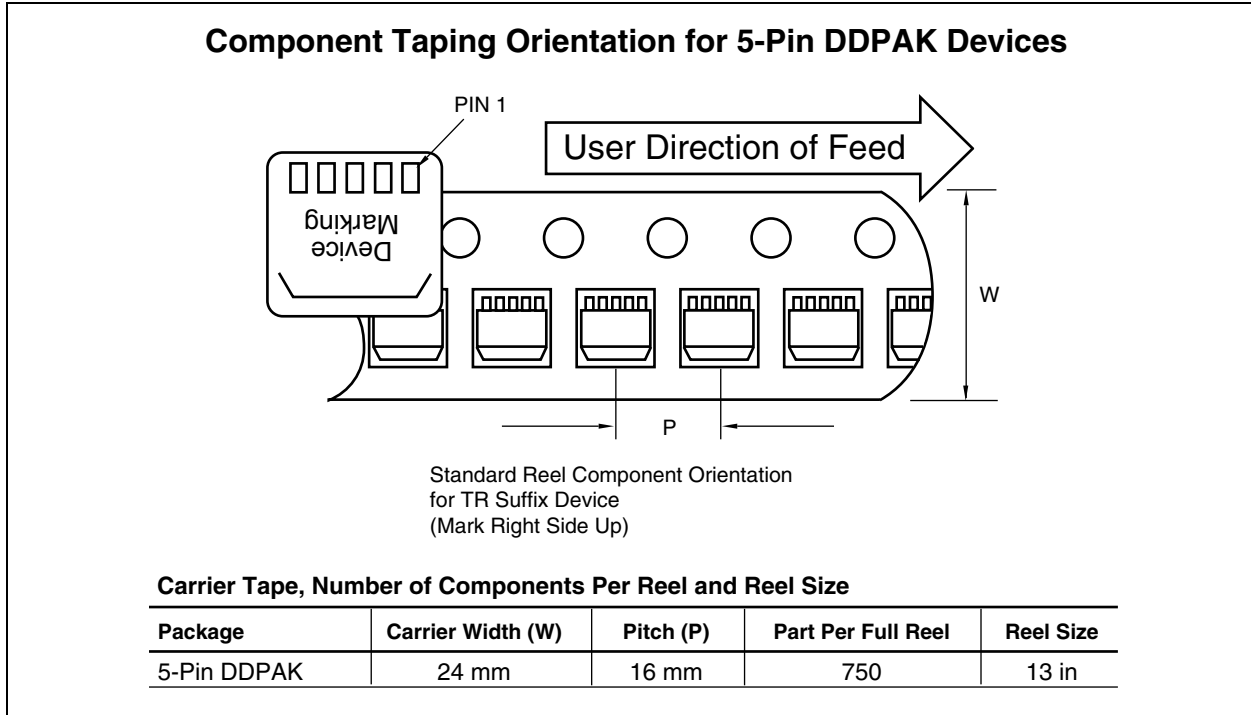


## 6.0 PACKAGING INFORMATION

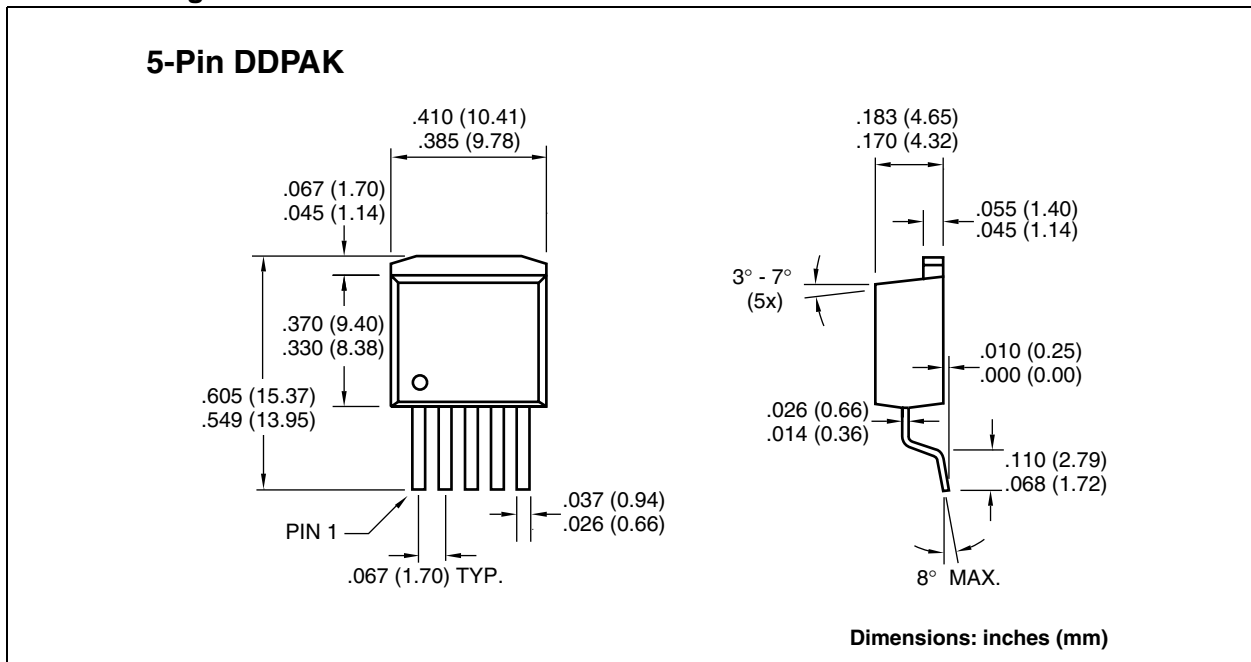
### 6.1 Package Marking Information

Package marking data not available at this time.

### 6.2 Taping Form



### 6.3 Package Dimensions



# TC1267

---

---

NOTES:

## SALES AND SUPPORT

### **Data Sheets**

Products supported by a preliminary Data Sheet may have an errata sheet describing minor operational differences and recommended workarounds. To determine if an errata sheet exists for a particular device, please contact one of the following:

1. Your local Microchip sales office
2. The Microchip Corporate Literature Center U.S. FAX: (480) 792-7277
3. The Microchip Worldwide Site ([www.microchip.com](http://www.microchip.com))

Please specify which device, revision of silicon and Data Sheet (include Literature #) you are using.

### **New Customer Notification System**

Register on our web site ([www.microchip.com/cn](http://www.microchip.com/cn)) to receive the most current information on our products.

# TC1267

---

NOTES:

Information contained in this publication regarding device applications and the like is intended through suggestion only and may be superseded by updates. It is your responsibility to ensure that your application meets with your specifications. No representation or warranty is given and no liability is assumed by Microchip Technology Incorporated with respect to the accuracy or use of such information, or infringement of patents or other intellectual property rights arising from such use or otherwise. Use of Microchip's products as critical components in life support systems is not authorized except with express written approval by Microchip. No licenses are conveyed, implicitly or otherwise, under any intellectual property rights.

## Trademarks

The Microchip name and logo, the Microchip logo, FilterLab, KEELOQ, microID, MPLAB, PIC, PICmicro, PICMASTER, PICSTART, PRO MATE, SEEVAL and The Embedded Control Solutions Company are registered trademarks of Microchip Technology Incorporated in the U.S.A. and other countries.

dsPIC, ECONOMONITOR, FanSense, FlexROM, fuzzyLAB, In-Circuit Serial Programming, ICSP, ICEPIC, microPort, Migratable Memory, MPASM, MPLIB, MPLINK, MPSIM, MXDEV, MXLAB, PICC, PICDEM, PICDEM.net, rPIC, Select Mode and Total Endurance are trademarks of Microchip Technology Incorporated in the U.S.A.

Serialized Quick Turn Programming (SQTP) is a service mark of Microchip Technology Incorporated in the U.S.A.

All other trademarks mentioned herein are property of their respective companies.

© 2002, Microchip Technology Incorporated, Printed in the U.S.A., All Rights Reserved.

 Printed on recycled paper.



*Microchip received QS-9000 quality system certification for its worldwide headquarters, design and wafer fabrication facilities in Chandler and Tempe, Arizona in July 1999 and Mountain View, California in March 2002. The Company's quality system processes and procedures are QS-9000 compliant for its PICmicro® 8-bit MCUs, KEELOQ® code hopping devices, Serial EEPROMs, microperipherals, non-volatile memory and analog products. In addition, Microchip's quality system for the design and manufacture of development systems is ISO 9001 certified.*



# MICROCHIP

## WORLDWIDE SALES AND SERVICE

### AMERICAS

#### Corporate Office

2355 West Chandler Blvd.  
Chandler, AZ 85224-6199  
Tel: 480-792-7200 Fax: 480-792-7277  
Technical Support: 480-792-7627  
Web Address: <http://www.microchip.com>

#### Rocky Mountain

2355 West Chandler Blvd.  
Chandler, AZ 85224-6199  
Tel: 480-792-7966 Fax: 480-792-7456

#### Atlanta

500 Sugar Mill Road, Suite 200B  
Atlanta, GA 30350  
Tel: 770-640-0034 Fax: 770-640-0307

#### Boston

2 Lan Drive, Suite 120  
Westford, MA 01886  
Tel: 978-692-3848 Fax: 978-692-3821

#### Chicago

333 Pierce Road, Suite 180  
Itasca, IL 60143  
Tel: 630-285-0071 Fax: 630-285-0075

#### Dallas

4570 Westgrove Drive, Suite 160  
Addison, TX 75001  
Tel: 972-818-7423 Fax: 972-818-2924

#### Detroit

Tri-Atria Office Building  
32255 Northwestern Highway, Suite 190  
Farmington Hills, MI 48334  
Tel: 248-538-2250 Fax: 248-538-2260

#### Kokomo

2767 S. Albright Road  
Kokomo, Indiana 46902  
Tel: 765-864-8360 Fax: 765-864-8387

#### Los Angeles

18201 Von Karman, Suite 1090  
Irvine, CA 92612  
Tel: 949-263-1888 Fax: 949-263-1338

#### New York

150 Motor Parkway, Suite 202  
Hauppauge, NY 11788  
Tel: 631-273-5305 Fax: 631-273-5335

#### San Jose

Microchip Technology Inc.  
2107 North First Street, Suite 590  
San Jose, CA 95131  
Tel: 408-436-7950 Fax: 408-436-7955

#### Toronto

6285 Northam Drive, Suite 108  
Mississauga, Ontario L4V 1X5, Canada  
Tel: 905-673-0699 Fax: 905-673-6509

### ASIA/PACIFIC

#### Australia

Microchip Technology Australia Pty Ltd  
Suite 22, 41 Rawson Street  
Epping 2121, NSW  
Australia  
Tel: 61-2-9868-6733 Fax: 61-2-9868-6755

#### China - Beijing

Microchip Technology Consulting (Shanghai)  
Co., Ltd., Beijing Liaison Office  
Unit 915  
Bei Hai Wan Tai Bldg.  
No. 6 Chaoyangmen Beidajie  
Beijing, 100027, No. China  
Tel: 86-10-85282100 Fax: 86-10-85282104

#### China - Chengdu

Microchip Technology Consulting (Shanghai)  
Co., Ltd., Chengdu Liaison Office  
Rm. 2401, 24th Floor,  
Ming Xing Financial Tower  
No. 88 TIDU Street  
Chengdu 610016, China  
Tel: 86-28-86766200 Fax: 86-28-86766599

#### China - Fuzhou

Microchip Technology Consulting (Shanghai)  
Co., Ltd., Fuzhou Liaison Office  
Unit 28F, World Trade Plaza  
No. 71 Wusi Road  
Fuzhou 350001, China  
Tel: 86-591-7503506 Fax: 86-591-7503521

#### China - Shanghai

Microchip Technology Consulting (Shanghai)  
Co., Ltd.  
Room 701, Bldg. B  
Far East International Plaza  
No. 317 Xian Xia Road  
Shanghai, 200051  
Tel: 86-21-6275-5700 Fax: 86-21-6275-5060

#### China - Shenzhen

Microchip Technology Consulting (Shanghai)  
Co., Ltd., Shenzhen Liaison Office  
Rm. 1315, 13/F, Shenzhen Kerry Centre,  
Renminnan Lu  
Shenzhen 518001, China  
Tel: 86-755-2350361 Fax: 86-755-2366086

#### China - Hong Kong SAR

Microchip Technology Hongkong Ltd.  
Unit 901-6, Tower 2, Metroplaza  
223 Hing Fong Road  
Kwai Fong, N.T., Hong Kong  
Tel: 852-2401-1200 Fax: 852-2401-3431

#### India

Microchip Technology Inc.  
India Liaison Office  
Divyasree Chambers  
1 Floor, Wing A (A3/A4)  
No. 11, O'Shaugnessey Road  
Bangalore, 560 025, India  
Tel: 91-80-2290061 Fax: 91-80-2290062

### Japan

Microchip Technology Japan K.K.  
Benex S-1 6F  
3-18-20, Shinyokohama  
Kohoku-Ku, Yokohama-shi  
Kanagawa, 222-0033, Japan  
Tel: 81-45-471-6166 Fax: 81-45-471-6122

### Korea

Microchip Technology Korea  
168-1, Youngbo Bldg. 3 Floor  
Samsung-Dong, Kangnam-Ku  
Seoul, Korea 135-882  
Tel: 82-2-554-7200 Fax: 82-2-558-5934

### Singapore

Microchip Technology Singapore Pte Ltd.  
200 Middle Road  
#07-02 Prime Centre  
Singapore, 188980  
Tel: 65-6334-8870 Fax: 65-6334-8850

### Taiwan

Microchip Technology Taiwan  
11F-3, No. 207  
Tung Hua North Road  
Taipei, 105, Taiwan  
Tel: 886-2-2717-7175 Fax: 886-2-2545-0139

### EUROPE

#### Denmark

Microchip Technology Nordic ApS  
Regus Business Centre  
Lautrup høj 1-3  
Ballerup DK-2750 Denmark  
Tel: 45 4420 9895 Fax: 45 4420 9910

#### France

Microchip Technology SARL  
Parc d'Activite du Moulin de Massy  
43 Rue du Saule Trapu  
Batiment A - 1er Etage  
91300 Massy, France  
Tel: 33-1-69-53-63-20 Fax: 33-1-69-30-90-79

#### Germany

Microchip Technology GmbH  
Gustav-Heinemann Ring 125  
D-81739 Munich, Germany  
Tel: 49-89-627-144 0 Fax: 49-89-627-144-44

#### Italy

Microchip Technology SRL  
Centro Direzionale Colleoni  
Palazzo Taurus 1 V. Le Colleoni 1  
20041 Agrate Brianza  
Milan, Italy  
Tel: 39-039-65791-1 Fax: 39-039-6899883

#### United Kingdom

Microchip Ltd.  
505 Eskdale Road  
Winnersh Triangle  
Wokingham  
Berkshire, England RG41 5TU  
Tel: 44 118 921 5869 Fax: 44-118 921-5820

05/01/02

